

ELDY THRUSTER (121/12)



FEATURES

- Compact, light weight and elegant design.
- Reliable and maintenance free operation.
- Smooth jerk free perfectly linear motion.
- Low noise and does not emit electrical disturbance.
- Suitable for out-door installation.
- Low power input.
- Easy mounting and dismounting.
- Bi-directional operation.
- Immune from external over-loading.
- Immune from supply voltage variations.

TECHNICAL DATA

THRUSTER MODEL	ELDY 121/12
LIFTING FORCE	120 Kg / 1200 N
STROKE	120 mm
CURRENT AT 415 VAC 50 HZ	1.2 Amps
POWER	410 Watt
OIL CAPACITY	9.8 Liters
WEIGHT	33 Kg
VOLTAGE	400 / 440 VAC, 3Ø
INGRESS PROTECTION	IP-65 IS/IEC 600529:2001
NO. OF START	720/ Hr
AMBIENT TEMPERATURE	-25°C + 50°C
INSULATION	Class F

★ 380V, 460V, 550V on Enquiry



**ELECTRO-HYDRAULIC THRUSTER
MODEL ELDY 121/12**

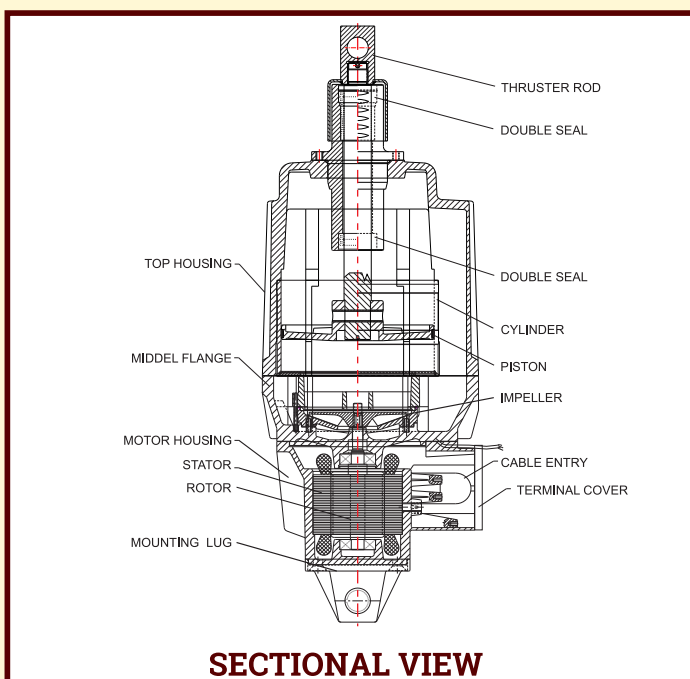

SECTIONAL VIEW

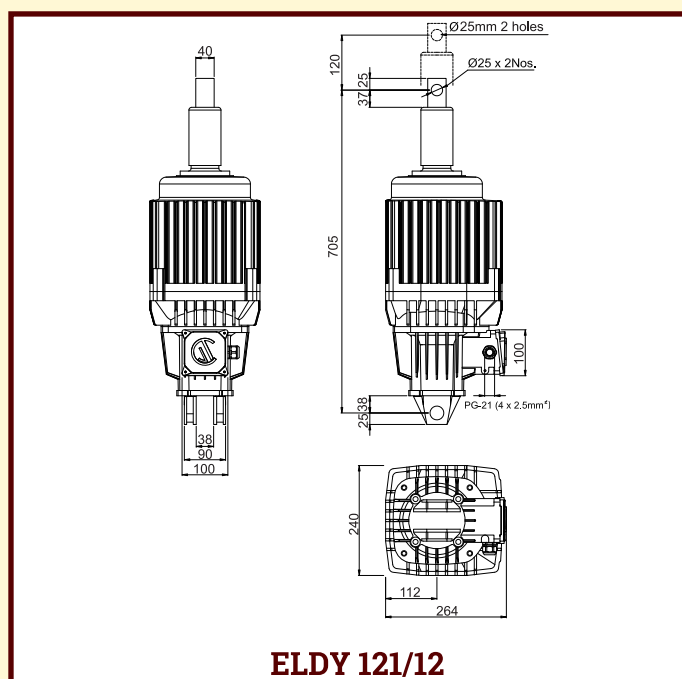

ELDY 121/12

H. O. Unit - I : C-15/16, Nand Jyot Industrial Estate, Andheri-Kurla Road, Mumbai - 400072,
Tel : (022) 42469700/730
E-mail : sales@socgroup.in

Unit - II: Plot No. 4912, G. I. D. C., Phase IV, Vatva, Ahmedabad - 382445
Tel.: (079) 68169700/702/712
E-mail : enquiry2@socgroup.in

Visit us at :
www.speedocontrols.com
www.socremote.com
www.socjoystick.com

**SPEED-O-CONTROLS
PVT. LTD.**
CRANE CONTROL GEAR