



Introduction

Reliable and Compact panels on either side of the chair, fitted with highly advanced master controllers which are light in operation and smooth in functioning, combined with a high degree of precision to ensure performance.

Features

- Arm Chair Units are provided for comfort of operate cranes.
- Reliable and compact.
- Adjustable height, facility automatic latching at desired position, revolves.
- Joystick master controllers advance light in operation.
- Components of proven design include selector Switches, including lamps, push buttons, foot switches etc.
- Arm Chair control units are made as per specification to suit tailor- made.
- Powder coated painted shade as per requirement.

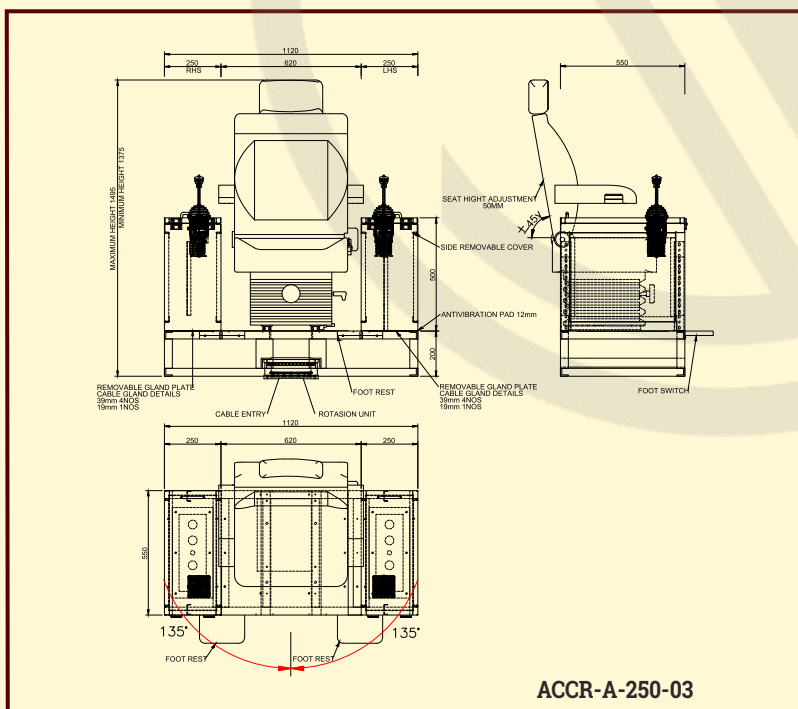

Joystick Controllers are modern and compact design used for flexible operations. Highly reliable and ease of maintenance makes them suitable for usage in high precision control of heavy machine. The controller handles can maximum operate at an angle of 42 degrees with a maximum operating force of 50N. Available with analog signal & Potentiometer.

TECHNICAL DATA

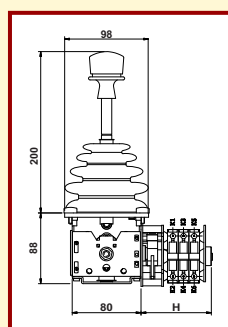
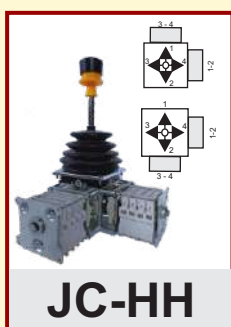
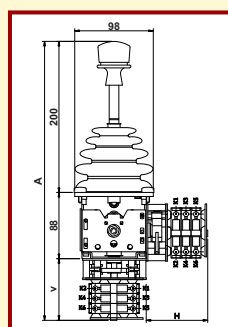
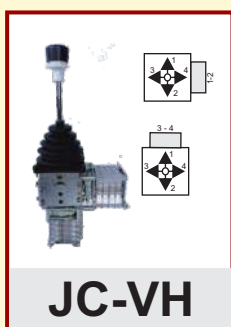
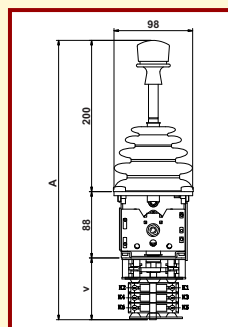
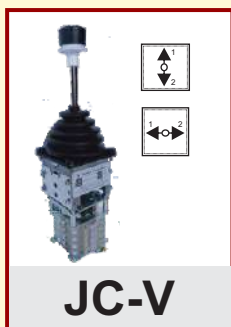
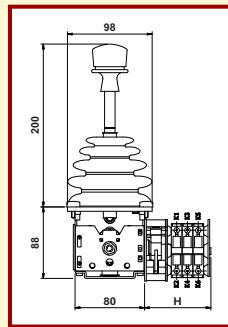

JOYSTICK MODEL	JC-H, JC-V, JC-VH, JC-HH
NUMBER OF AXIS	SINGLE/DUAL
POWER SUPPLY VOLTAGE	24VDC/48-220VAC
NO OF STEP (n)	5 MAX (n denotes no of steps)
SPRING RETURN	CONFIGURABLE
DEADMAN BUTTON	CONFIGURABLE
MECHANICAL ANGLE	±42°
MECHANICAL LIFE	10 Million
OPERATING TEMPERATURE	-40°C TO +80°C
DEGREE OF PROTECTION	IP-64
ENCLOSURE	CONFIGURABLE
CONTACT RATED CURRENT	10A
CONTACT RATED VOLTAGE	500 VAC MAX

MODEL	MODEL	CONTACT PER MOTION	A	V	H
JC-H-n/4	JC-V-n/4	2 CONTACTS	340	55	55
JC-H-n/8	JC-V-n/8	4 CONTACTS	355	70	70
JC-H-n/12	JC-V-n/12	6 CONTACTS	370	85	85
JC-H-n/16	JC-V-n/16	8 CONTACTS	385	100	100
JC-H-n/20	JC-V-n/20	10 CONTACTS	400	115	115
JC-H-n/24	JC-V-n/24	12 CONTACTS	415	130	130

SR = SPRING RETURN

MI = MECHANICAL INTERLOCK

DH = DEADMAN HANDLE

SP = STAY PUT

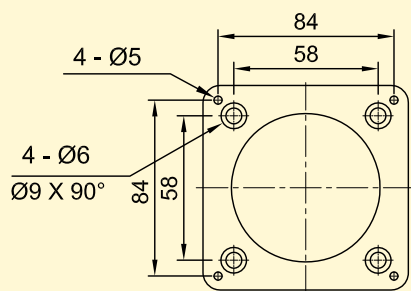

Mounting Dimension

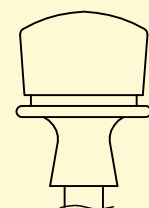

MI

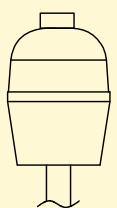

DH