

LIMIT SWITCHES SPARE COMPONENTS

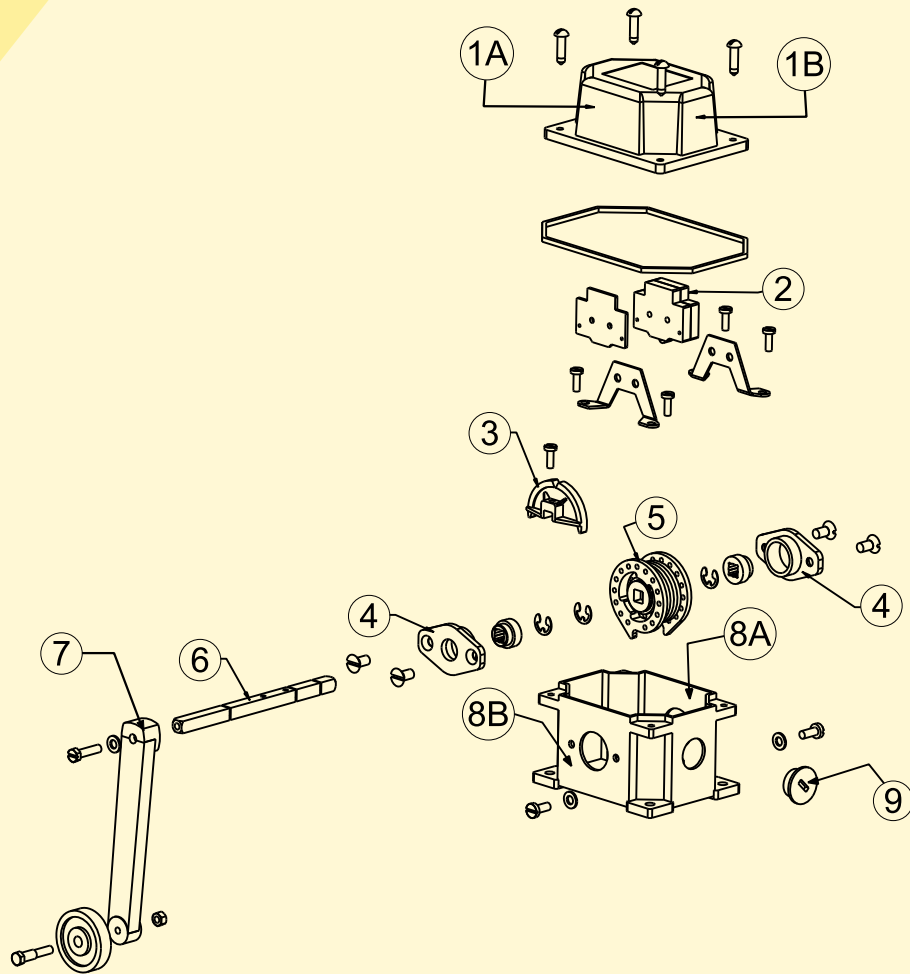

BLOW UP FOR LEVER OPERATED LIMIT SWITCHES(10AMPS)



SPARES FOR LEVER OPERATED LIMIT SWITCHES(10AMPS)

<p>1A</p>  <p>TOP COVER TP (10LLTCTP)</p>	<p>1B</p>  <p>TOP COVER AL (10LLTCAL)</p>	<p>2</p>  <p>CONTACT ELEMENT ASSEMBLY (10LLCA)</p>	<p>3</p>  <p>CAMS (10LLCM)</p>	<p>4</p>  <p>START/END BUSH (10LLSB/10LLEB)</p>	
<p>5</p>  <p>SPRING ASSEMBLY (10LLSRA)</p>	<p>6</p>  <p>CAM SHAFT (10LLCS)</p>	<p>7</p>  <p>ROLLER WITH LEVER (10LLRL)</p>	<p>8A</p>  <p>BOTTOM COVER TP (10LLBCTP)</p>	<p>8B</p>  <p>BOTTOM COVER AL (10LLBCAL)</p>	<p>9</p>  <p>CABLE GLAND BUTTON (10LLCGB)</p>

H. O. Unit -I : C-15/16, Nand Jyot Industrial Estate, Andheri-Kurla Road, Mumbai - 400072 ,
Tel : (022) 42469700/730
E-mail : sales@socgroup.in

Unit - II: Plot No. 4912, G. I. D. C., Phase IV, Vatva, Ahmedabad - 382445
Tel.: (079) 68169700/702/712
E-mail : enquiry2@socgroup.in

Visit us at :
www.speedocontrols.com
www.socremote.com
www.socjoystick.com

SPEED-O-CONTROLS PVT. LTD. 
CRANE CONTROL GEAR V5