



INTRODUCTION

Rotary Geared Limit Switch GRLS is used to trip motor supply when the moving loads reach the extreme end positions of working zone. The driving motion is transmitted by worm gear through worm shaft. The rotations & movements are transmitted to switches by adjustable cams. Complying to IEC/EN 60947-5-1, IEC/EN 60529, IEC 60068-2-78, IEC 60068-2-30.

APPLICATION

A Rotary Geared Limit Switch are suitable for use on reversing drives such as Hoists, Winches, Rolling Mills & various other mechanisms used in steel plants such as Coke Oven, Feeding Oven Machinery etc.

MECHANICAL DATA

RATIO	EFFECTIVE ROTATIONS	USEFUL ROTATIONS	4 CONTACTS MODEL
96:1	96	92	GRLS/96/4SH

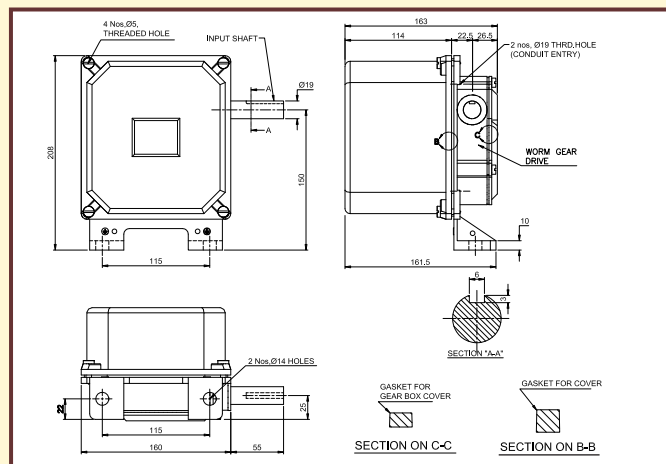
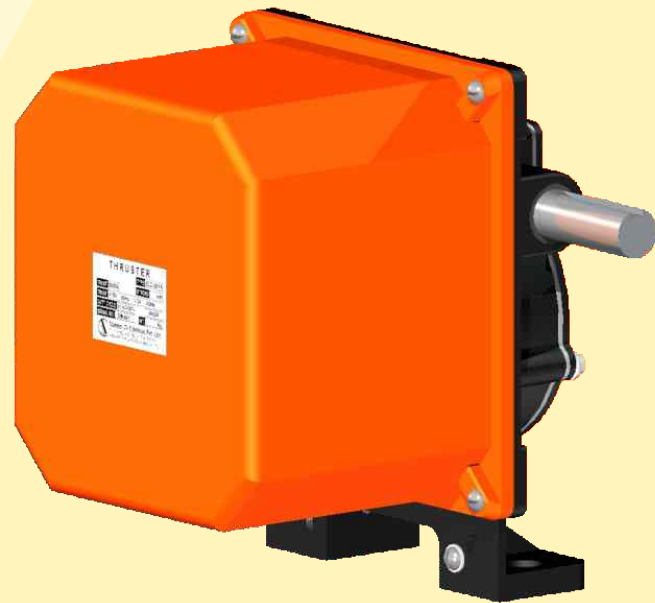

BODY MATERIAL	Aluminium Die Cast
PROTECTION DEGREE	IP-55 Confirming to IS/IEC : 60529(2001)
GEAR RATIO	96:1
DRIVE	Worm Drive
CABLE ENTRIES	2x3/4" Conduit
CONTACT MATERIAL	Silver Cadmium
RATED VOLTAGE INSULATION	500 V.A.C.
THERMAL TEST CURRENT	40 Amps
NO. OF CONTACTS	4NC/2NO+2NC
CAM SETTING	Adjustable

