

THRUSTER BRAKE ELDY SMD (400-50/06)



TECHNICAL DATA

ITEM	BRAKE	THRUSTER
MODEL	SMD 400-50/06	ELDY - 50/06
DRUM DIA	400 mm	-----
BRAKE SHOE FRICTION COEFFICIENT	Asbestos free / Without Rivet / BA	-----
BRAKING TORQUE	86 Kgm / 860 Nm	-----
THRUST	-----	50 Kg
STROKE	-----	60 mm
OIL + CAPACITY	-----	Transformer Oil IS-335 (4.5 Liters)Max
RATED VOLTAGE	-----	415 V ± 10% 50 Hz 3Ph AC
CURRENT AT 415 V AC INRUSH CURRENT	-----	0.5 Amps 2.5 Amps.(Inrush)
INSULATION	-----	F Class
INGRESS PROTECTION	-----	IP - 65 IS/IEC 60529 (2001)
AMBIENT TEMPERATURE	-----	50° C
POWER	-----	330 Watt
WEIGHT	74 Kg	20 Kg
PAINTING	Hammertone Gray Paint	
LAF	Asbestos Free Liner	
OPTIONAL FEATURES		
SCD	Aluminum Brake Shoe as per DIN - 15435	
LWA	Lining Wear Adjuster	
LWI	Lining Wear Indicator Limit Switch	
SS	AISA 420 Hardened & Tampered Stainless Steel Pins	
PN	Lubricators on Pins	
OL	Open Brake Limit Switch	
MS	Manual Opening & Locking System	

* Non-Standard voltages available on enquiry

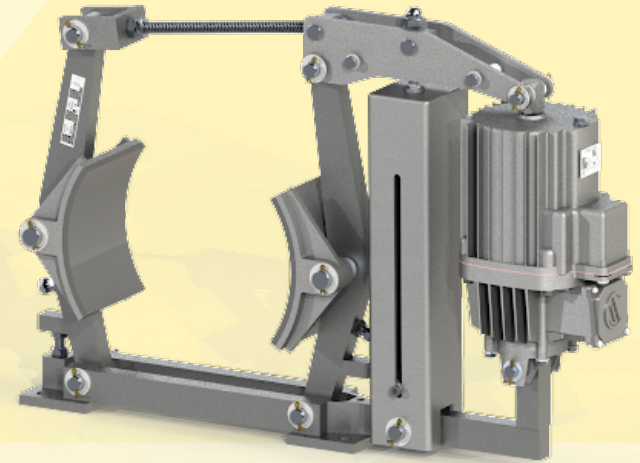

SELECTION OF BRAKE SIZE

SMD Thruster brakes are steel fabricated frames with Eldy Thruster as per din standard.

Excellent designs & good manufacturing process ensure a reliable product.

The brake torque must be $= >$ than motor full load as referred with drum. Formula as below:

$$T = \text{Torque in Kgm} = \frac{716 \times \text{Hp}}{\text{rpm}}$$

$$T = \text{Torque in Nm} = \frac{9552 \times \text{Kw}}{\text{rpm}}$$

Where Hp/Kw = motor output & rpm = Rev/minute

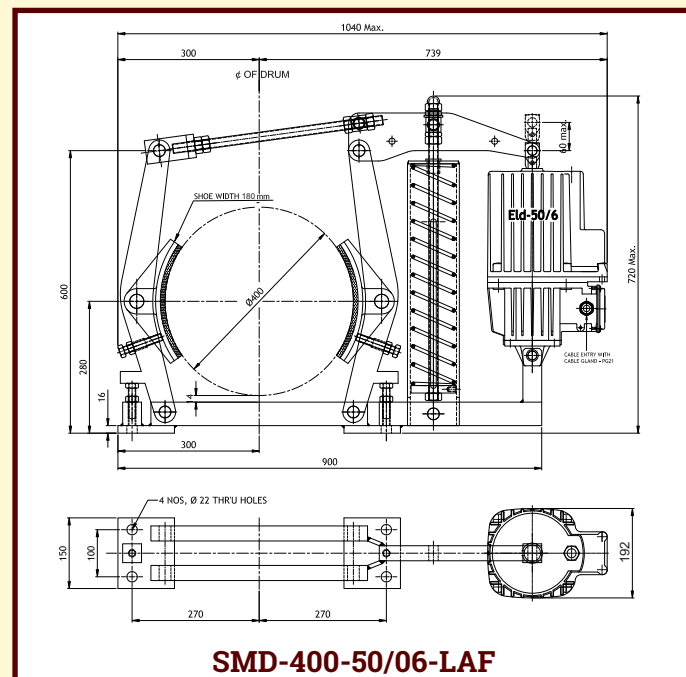
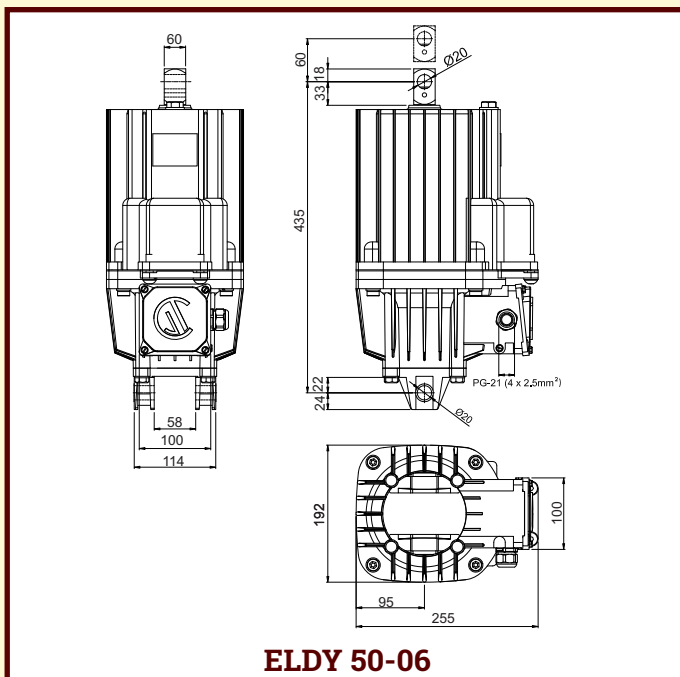

H. O. Unit - I : C-15/16, Nand Jyot Industrial Estate, Andheri-Kurla Road, Mumbai - 400072,
Tel : (022) 42469700/730
E-mail : sales@socgroup.in

Unit - II: Plot No. 4912, G. I. D. C., Phase IV, Vatva, Ahmedabad - 382445
Tel.: (079) 68169700/702/712
E-mail : enquiry2@socgroup.in

Visit us at :
www.speedocontrols.com
www.socremote.com
www.socjoystick.com

SPEED-O-CONTROLS PVT. LTD.
CRANE CONTROL GEAR V5