

ELECTRO-HYDRAULIC THRUSTER (ST)-870



INTRODUCTION

An Electro-hydraulic thruster is a device that develops linear thrust (or force) required to operate the required mechanism. The input to the device is a three-phase supply. The thrusters are widely used to actuate. Thruster shoe Brakes, commonly used in material handling machines. Thrusters in various models develop 15 kg to 295 kg. In stroke lengths of 51 mm, 76 mm & 127 mm.

Thrusters should be mounted with in $\pm 10^\circ$ from vertical. Working fluid Thrusters should be mounted with in $\pm 10^\circ$ from vertical. Working fluid - Transformer oil to BS 148.

TECHNICAL DATA

THRUSTER MODEL	ST - 870
LIFTING FORCE	68 Kg
STROKE	76 mm
CURRENT	0.7 Amps
POWER	200 Watt
OIL CAPACITY	5 Liters Transformer Oil
WEIGHT	34 Kg
VOLTAGE A.C.	415V 3 \emptyset ,AC
INGRESS PROTECTION	IP-55 (IS/IEC 600529:2001)
AMBIENT TEMPERATURE	50°C Max
NO.OF START	720/hr

★ 380V, 460V, 550V on Enquiry

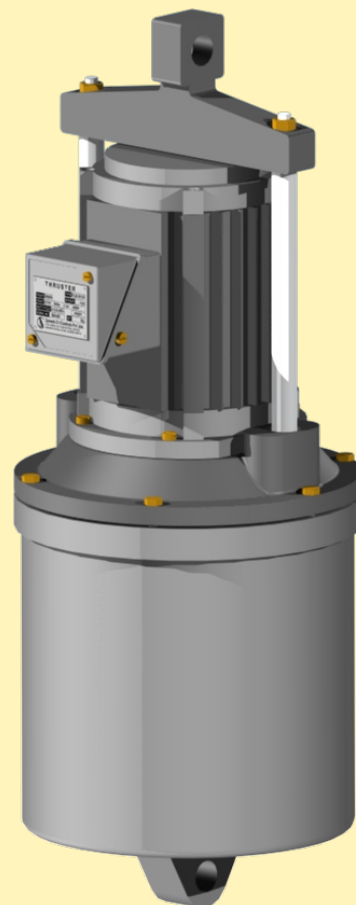

**ELECTRO-HYDRAULIC THRUSTER
MODEL ST 870**

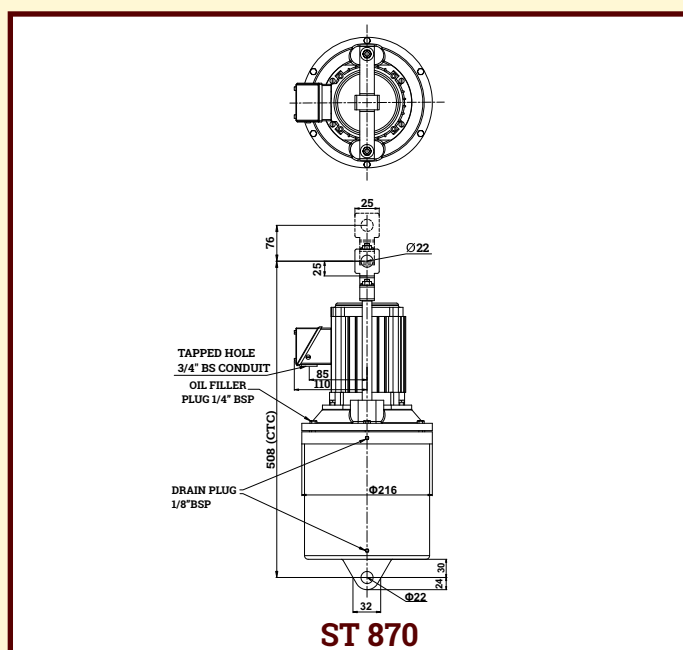
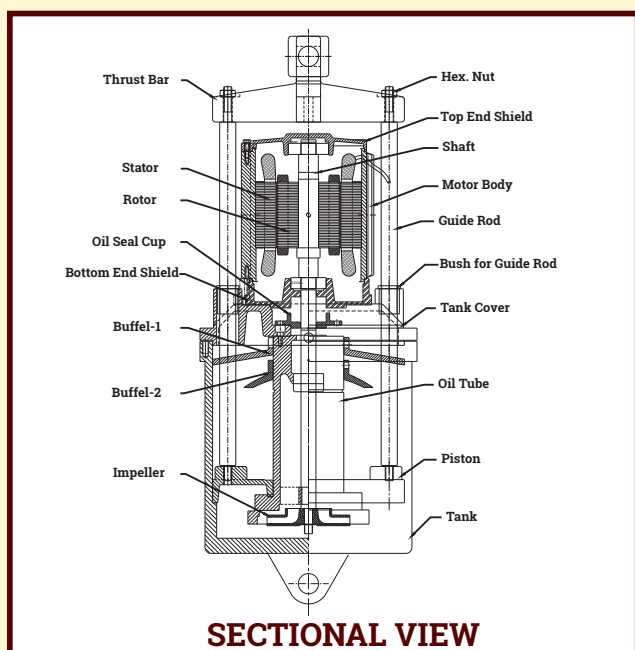

H. O. Unit - I : C-15/16, Nand Jyot Industrial Estate, Andheri-Kurla Road, Mumbai - 400072,
Tel : (022) 42469700/730
E-mail : sales@socgroup.in

Unit - II: Plot No. 4912, G. I. D. C., Phase IV, Vatva, Ahmedabad - 382445
Tel.: (079) 68169700/702/712
E-mail : enquiry2@socgroup.in

Visit us at :
www.speedocontrols.com
www.socremote.com
www.socjoystick.com

**SPEED-O-CONTROLS
PVT. LTD.**
CRANE CONTROL GEAR