



**SPEED-O-CONTROLS  
PVT. LTD.**



**FLAMEPROOF EQUIPMENTS**

# FLAMEPROOF PENDANTS

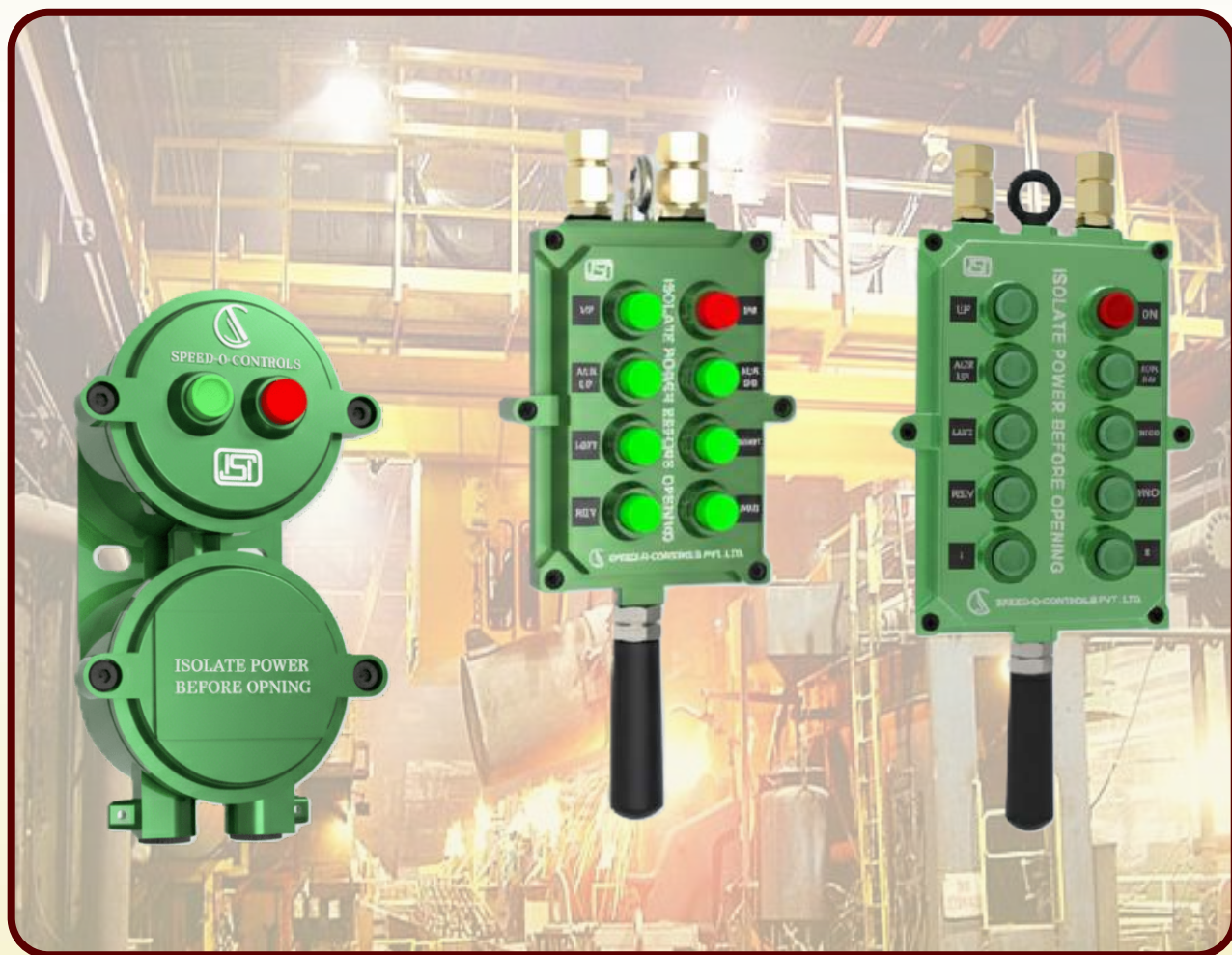

**DISCOVER OUR RANGE OF FLAMEPROOF FOR CRANES**



## INDEX

**FLP PENDANT IIB  
(2P)**



[\(CLICK HERE\)](#)

**FLP PENDANT IIB  
(6+2P)**



[\(CLICK HERE\)](#)

**FLP PENDANT IIB  
(8+2P)**



[\(CLICK HERE\)](#)

# Flame Proof IIA / IIB Pendant Push Button Station



## Introduction

Flame-proof **Pendant Push Button** FLP P2-IIB is used to ON/OFF switching of contactors etc. These are suitable for use in explosive gases, as specified Gas groups I, IIA and IIB, as per IS/IEC 60079-0-2007 & IS/IEC60079-1-2007.

## Operation:

A two (1NO+1NC) Contact elements are provided. The FLP Pendant Box with IP-55 degree of protection are available in desired NO/NC contacts combinations

## G.A.Drawing

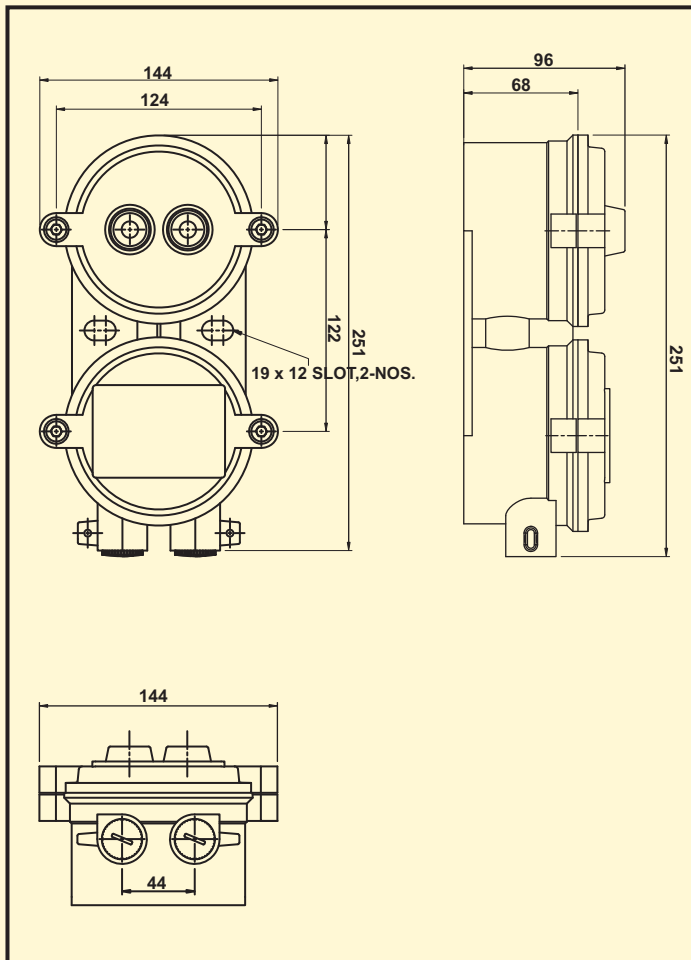

[CLICK HERE FOR INDEX](#)



## Technical Data

Explosive Atmosphere Part I Equipment Protection by Flameproof Enclosures "d"	
<b>Product</b>	Pendant Push Button
<b>Zone</b>	Zone I, Gas Groups I, IIA & IIB
<b>Model</b>	FLP P2-IIB
<b>Voltage</b>	500 VAC
<b>Current</b>	10 A AC
<b>Ambient Temperature</b>	-20°C + 40°C
<b>Enclosure</b>	Aluminium Alloy LM 4
<b>Ingress Protection</b>	IP-55(IEC 60529(1989))
<b>Cable Entry</b>	M 20 Single
<b>IS</b>	IS/IEC 60079-0-2004 IS/IEC 60079-1-2007
<b>BIS License No.</b>	CM/L-7200042490 as per IS/IEC60079-1-2007
<b>Certificate No.</b>	CIMFR/TC/P/245 Date:15-04-2019 Central Institute Of Mining & Fuel Research
<b>Petroleum &amp; Explosive Safety Organization (PESO)</b>	A/P/HQ/GJ/104/5699(P455000) Date:26/09/2019

H. O. Unit -I: C-15/16, Nand Jyot Industrial Estate, Andheri-Kurla Road, Mumbai - 400072,  
Tel : (022) 42469700/730  
E-mail : sales@socgroup.in

Unit - II: Plot No. 4912, G. I. D. C., Phase IV, Vatva, Ahmedabad - 382445  
Tel.: (079) 68169700/702/712  
E-mail : enquiry2@socgroup.in

Visit us at :  
www.speedocontrols.com  
www.socremote.com  
www.socjoystick.com

**SPEED-O-CONTROLS PVT. LTD.**  
**FLAMEPROOF EQUIPMENTS**  **V6**  
01/11/25

# Flame Proof IIA / IIB Pendant Push Button Station



## Introduction

Flame Proof enclosure for push button pendant station used for E.O.T cranes & Hoist application. Enclosure is designed to meet the requirements as specified in IS/IEC -60079-1-2007. The enclosure is certified by Karandikar laboratories Pvt.Ltd. for use in Gas Group I, IIA & IIB zone 1. The pendant push button station with 8 push button (6+2) maximum for operation of E.O.T. cranes. The contacts provided are 10 amps rated as 240 VAC.

## Features

- Quick & easy assembly
- Adequate cabling space
- Double row 10 buttons max
- Emergency Stop
- Contacts 10 A

## G.A. Drawing

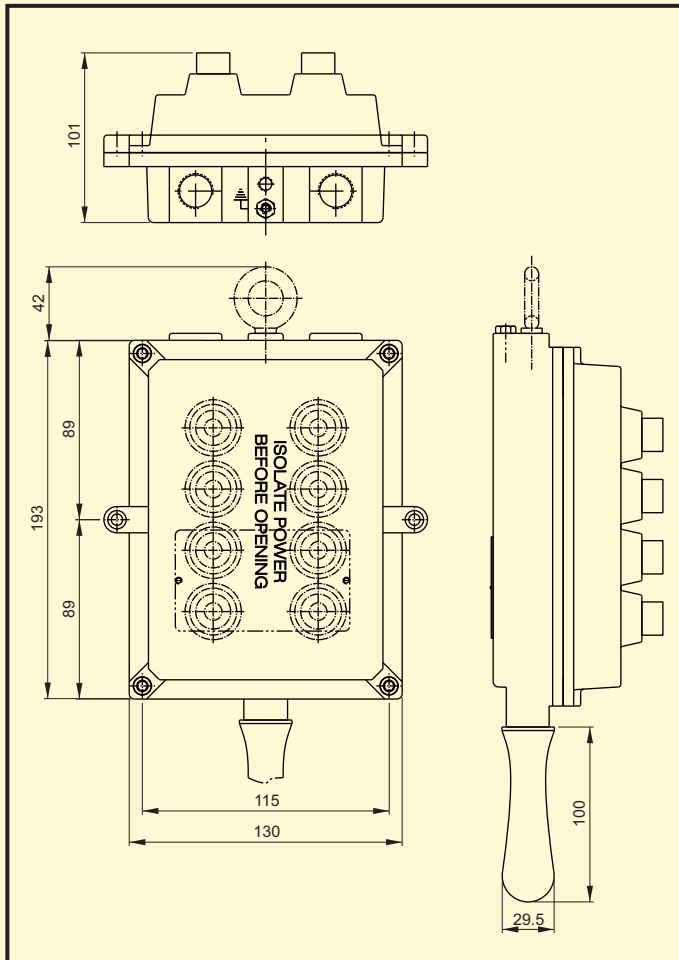

[CLICK HERE FOR INDEX](#)

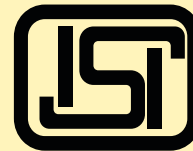

## Technical Data

Explosive Atmospheres Part I Equipment Protection By Flameproof Enclosure "d"	
Product	Pendant Push Button
Zone	Zone I, Gas group IIA & IIB
Model	FLP-P6+2 -IIA-IIB
Voltage	Up to 240 VAC Max
Current	10A AC Max
Ambient temperature	T6
Enclosure	Aluminum Alloy LM 4
Ingress Protection	IP-54 as per IS/IEC-60529-2001
Cable Entry	Double, M20 x 1.5p ISO:965 1 & 3
IS	IS/IEC-60079-0-2007 IS/IEC-60079-1-2007 IS/IEC-600529 : 2001
Certificate No FLP Enclosure	IIN/CIMFR/TR24/R/852 Date : 08-08-2024 Central Institute Of Mining & Fuel Research
BIS License No.	CM/L-7200208195 20-07-2021
PESO Certificate No	A/P/HQ/GJ/104/6359/P639817/3 Date : 16-07-2025

# Flame Proof IIA / IIB Pendant Push Button Station



## Introduction

Flame Proof enclosure for push button pendant station used for E.O.T cranes & Hoist application. Enclosure is designed to meet the requirements as specified in IS/IEC -60079-1-2014. The enclosure is certified by Karandikar laboratories Pvt.Ltd.for use in Gas Group IIA & IIB zone 1. The pendant push button station with 10 push button (8+2) maximum for operation of E.O.T. cranes. The contacts provided are 10 amps rated as 240 VAC.

## Features

- Quick & easy assembly
- Adequate cabling space
- Double row 10 buttons max
- Emergency Stop
- Contacts 10 A

## G.A.Drawing

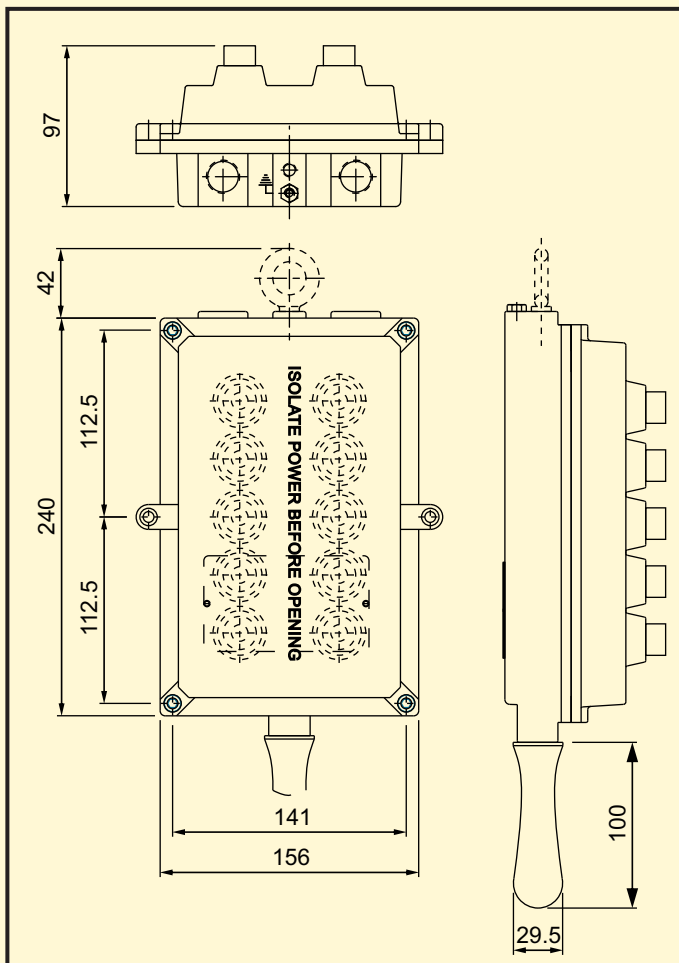

[CLICK HERE FOR INDEX](#)

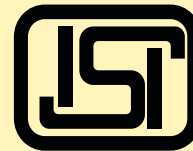
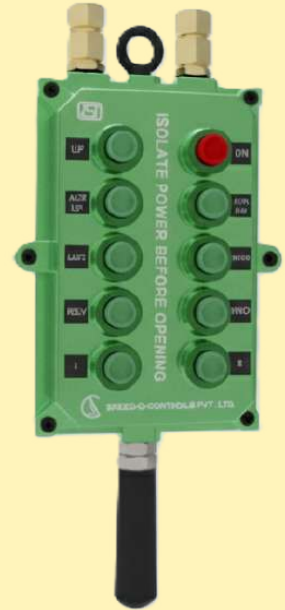

## Technical Data

Explosive Atmospheres Part I Equipment Protection By Flameproof Enclosure "d"	
Product	Pendant Push Button
Zone	Zone I, Gas group IIA & IIB
Model	FLP-P8+2 -IIA-IIB
Voltage	Up to 240 VAC Max
Current	10A AC Max
Ambient temperature	T6
Enclosure	Aluminum Alloy LM 4
Ingress Protection	IP-54 as per IS/IEC-60529-2001
Cable Entry	Double, M20 x 1.5p ISO:965 1 & 3
IS	IS/IEC-60079-0-2017 IS/IEC-60079-1-2014
Certificate No FLP Enclosure	KLPL/Ex/15-104X Date : 12-01-2021 Karandikar Laboratories Pvt. Ltd
BIS License No.	CM/L-7200208195 DATE - 20-07-2021
PESO Certificate No	A/P/HQ/GJ/104/5969 (P529363/3) Date - 09-11-2022

### CRANE CONTROL GEAR



### POWER DISTRIBUTION

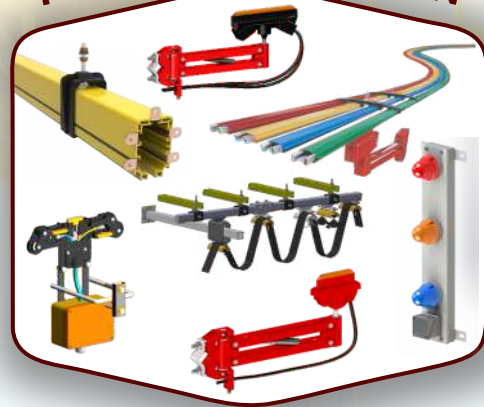

### RADIO REMOTE CONTROLS



### JOYSTICK CONTROLLER



### FLAMEPROOF PRODUCTS



### OTHER ELECTRONICS



“Our Customer do not buy products. They buy the benefits that our products provides.”

H. O. Unit -I : C-15/16, Nand Jyot,  
Industrial Estate, Andheri-Kurla, Road,  
Mumbai - 400072 ,  
Tel : (022) 42469700-730,  
E-mail : sales@socgroup.in

Visit us at :  
[www.speedocontrols.com](http://www.speedocontrols.com)  
[www.socremote.com](http://www.socremote.com)  
[www.socjoystick.com](http://www.socjoystick.com)

Unit - II: Plot No. 4912, G. I. D. C.,  
Phase IV, Vatva,  
Ahmedabad - 382445  
Tel.: (079) 68169700/702/712,  
E-mail : enquiry2@socgroup.in